

HiFi ENGINE®

For more Hi-Fi manuals and set-up information
please visit www.hifiengine.com

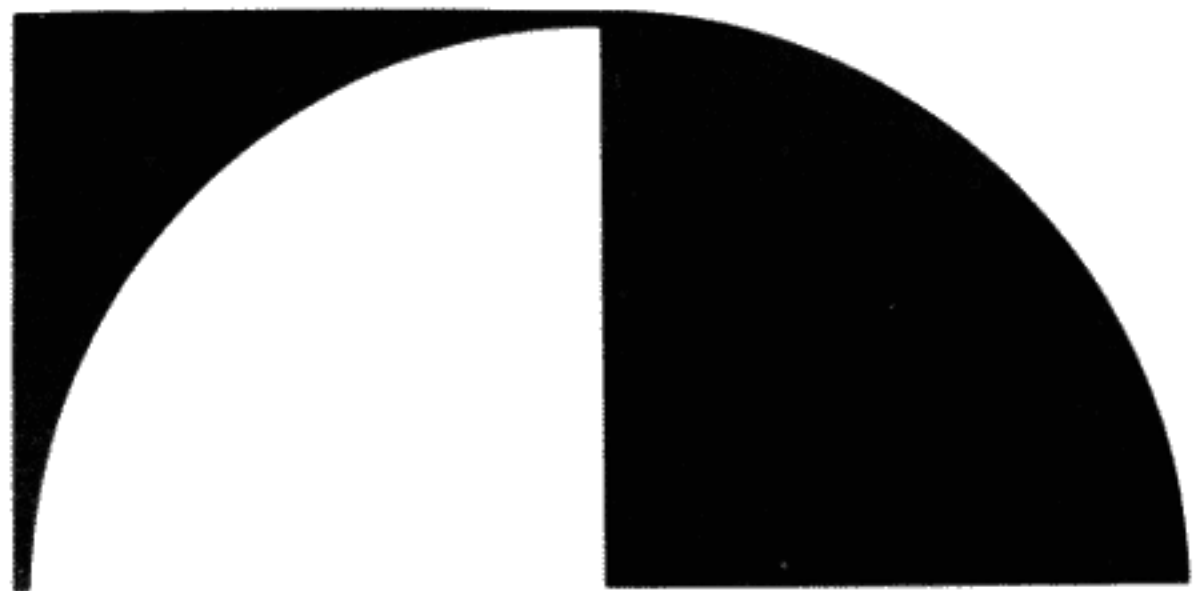

Nakamichi

2 Head Cassette Deck

Owner's Manual

580

WARNING

TO PREVENT FIRE OR SHOCK
HAZARD, DO NOT EXPOSE
THIS APPLIANCE TO RAIN OR
MOISTURE.

Please record the Serial Number in the
space below to have it as a reference.

Model Number : Nakamichi 580
Serial Number _____

Please read all accompanying Warranty
cards and/or notices very carefully.

CONTENTS

CONTROLS AND FEATURES . . .	1
PRECAUTIONS	3
CONNECTIONS	4
PLAYBACK	5
RECORDING	6
SPECIAL FEATURES	8
RECOMMENDED TAPE	9
RECORD CALIBRATION AND BIAS ADJUSTMENT	10
THE DOLBY SYSTEM	12
MAINTENANCE	13
TROUBLESHOOTING	15
SPECIFICATIONS	16

Congratulations!

You have chosen one of the finest cassette decks on the market today. The 580 is the latest in a long line of Nakamichi audio components designed and built with quality, to deliver the utmost in performance. It features some of the most advanced technology in cassette deck history, including the incredible Nakamichi Crystalloy SuperHead, a totally new diffused-resonance mechanism, a unique high-current erase head, and a noiseless logic-controlled transport with high-speed cueing.

Nakamichi products are internationally famous for state-of-the-art engineering and manufacture, which are your assurance that your 580 will bring you many years of trouble-free enjoyment.

At the moment, the controls and features of the 580 may be unfamiliar to you. This manual has been designed to acquaint you with the 580 in the shortest possible time. The first part of this manual will help you connect and operate your 580. The remaining sections deal with topics such as tape selection and Dolby Noise Reduction, and may be read at your leisure.

Thank you.

Nakamichi Corporation

Controls and Features

(1) Acrylic Cassette Compartment Cover
Can be easily detached to allow access to the heads and transport parts for routine maintenance. See page 13.

(2) Eject Button
Press to smoothly eject the cassette. It is not possible to eject the cassette while the tape is in motion.

(3) Cassette Lid
Ensures proper alignment of cassette for insertion. See-thru design provides an unobstructed view of the cassette, once inserted.

(4) Headphone Jack
Accepts standard 1/4-inch stereo plug.

(5) Head Height and Azimuth Alignment Screws
These adjustments have been calibrated at the factory for optimum performance. Readjustment should only be done by qualified service technicians.

(6) Pause/Cue Button
Used for noise-free stopping of the tape in the record mode. Also halts tape motion in the play mode. Allows cueing in the rewind and fast-forward modes. See page 8.

(7) Record Button
Puts the 580 into the record mode. See page 6.

(8) Fast-Forward Button
Moves tape rapidly in the forward direction.

(9) Rewind Button
Moves tape rapidly in the reverse direction.

(10) Stop Button
Stops the transport from fast-forward, rewind, record or play when pressed.

(11) Play Button
Starts the transport motion forward at the standard 1-7/8 inches per second for record and playback.

(12) Output Level Control
Controls the output level of the 580 during record and playback. Has no effect on record levels. In the maximum (fully clockwise) position, the output for each channel will be 1 V at a meter reading of 0 dB.

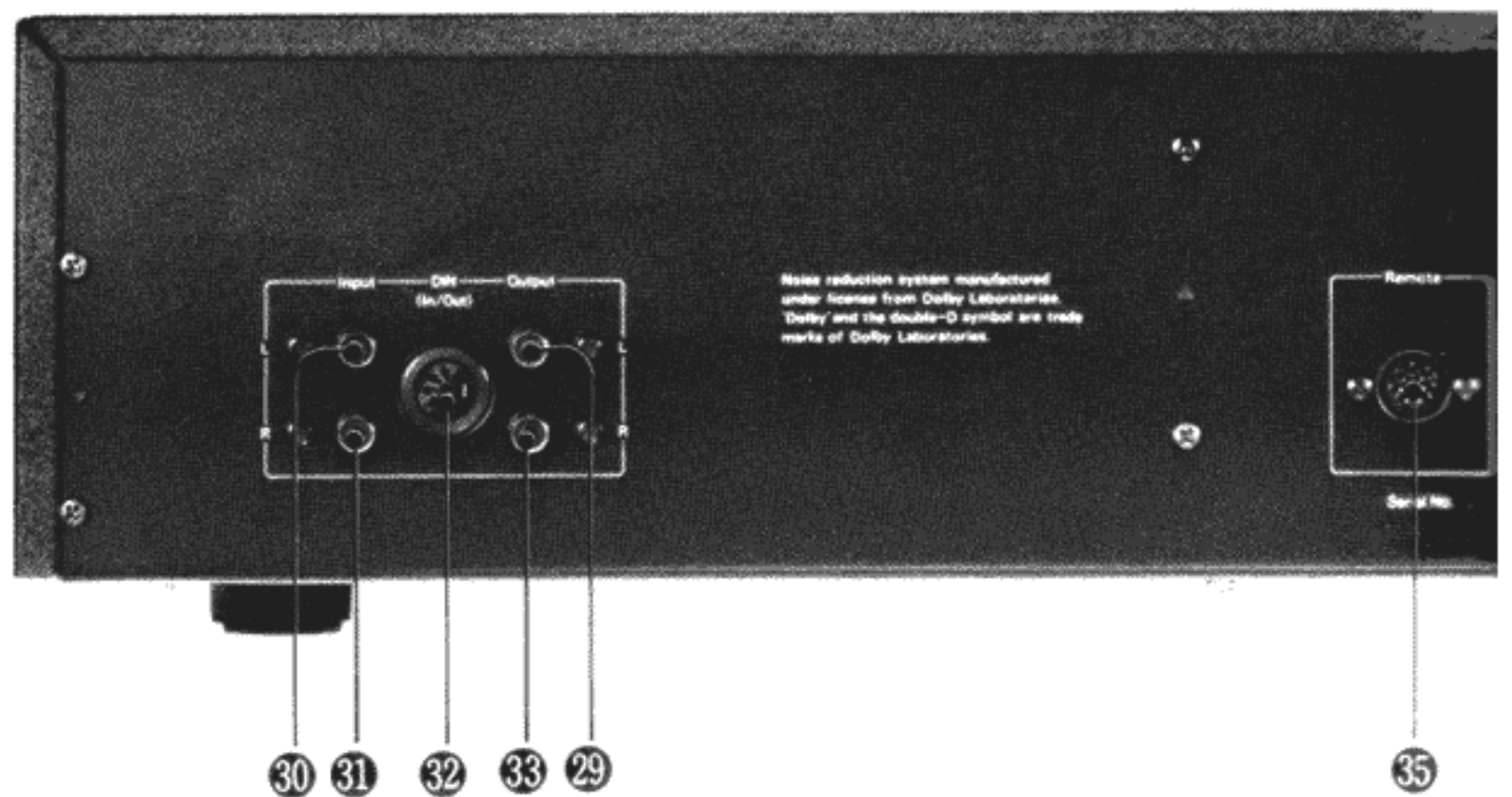
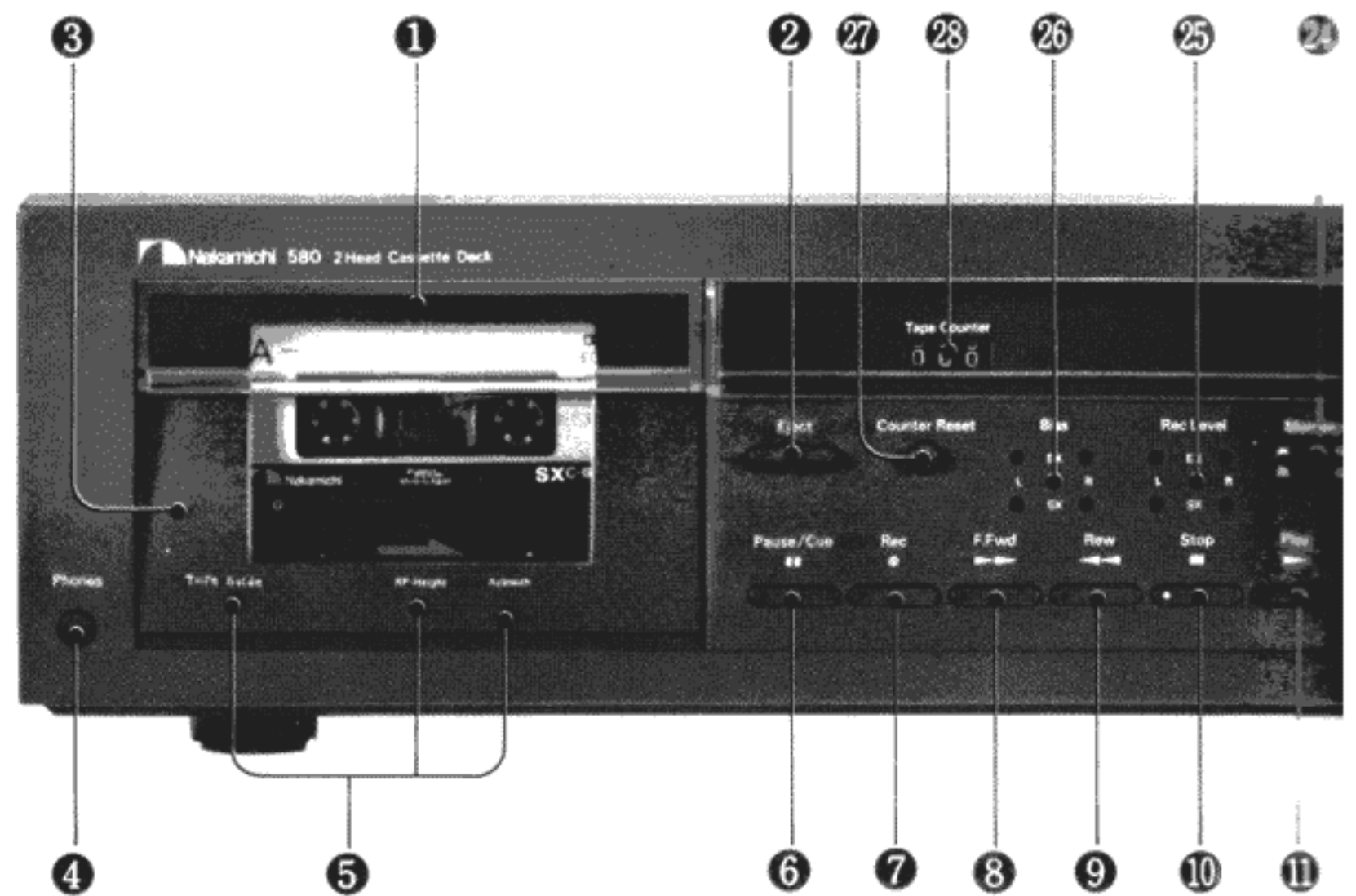

(13) Balance Control
Controls the relative balance between the left and right inputs. Has no effect on playback levels.

(14) Input Level Control
Controls the input (record) levels for the left and right channels simultaneously.

(15) Power Switch
Activates the 580. The level meters and cassette compartment will illuminate to indicate that the power is on.

(16) Peak Level Meters
The meters indicate peak program levels from -40 to +7 dB. The 0 dB level conforms to the Dolby standard of 200 nanowebers per meter.

(17) Dolby NR Switch
Activates Dolby Noise Reduction circuitry, which reduces tape hiss by as much as 10 dB when used during record and playback. See page 12.

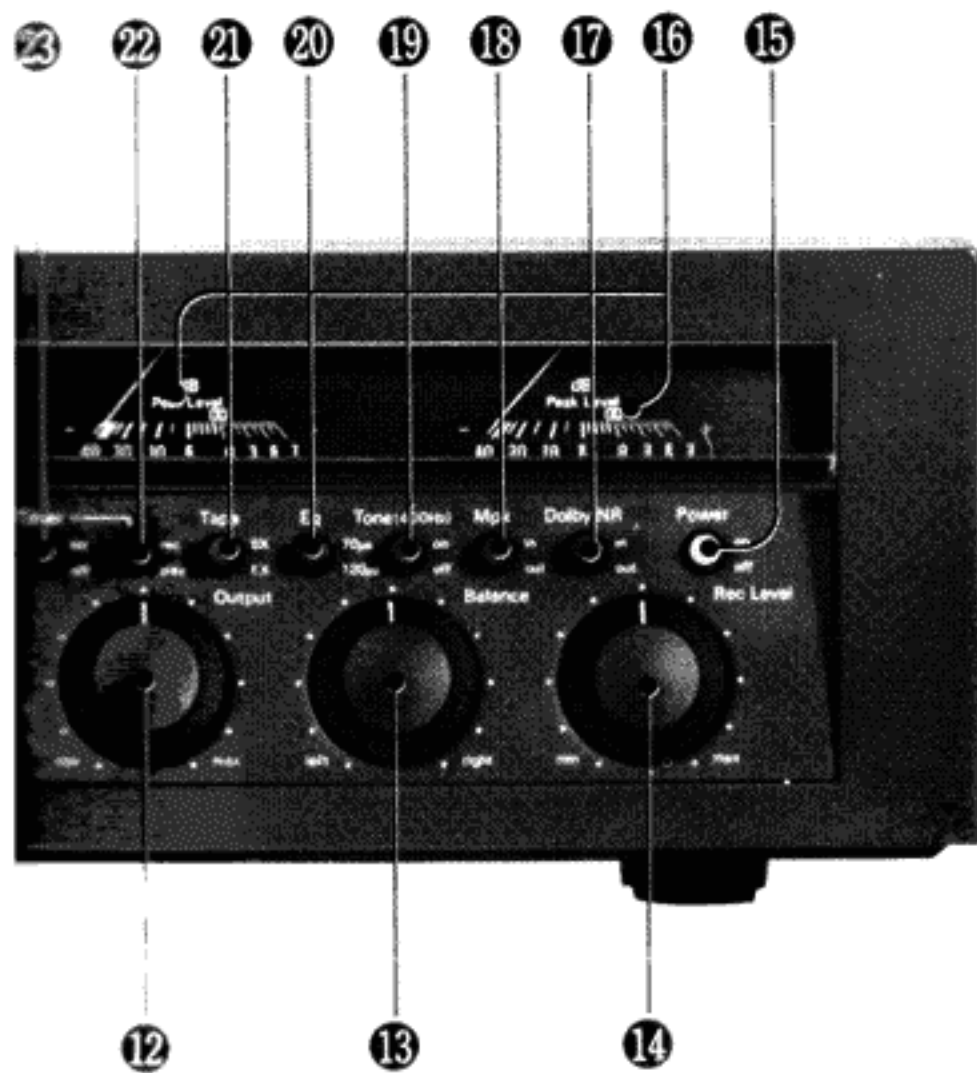

(15) MPX Filter Switch

Inserts a filter to attenuate the 19 kHz multiplex carrier signal present in FM stereo broadcasts. This carrier can "fool" the Dolby circuit. The switch should be "out" when receiving anything other than FM stereo broadcasts.

(16) 400 Hz Test Tone Switch

Activates a 400 Hz, 0 dB oscillator for record calibration.

(20) Eq Switch

Allows the choice of the proper record and playback equalization for different types of tape. You can select either 120 or 70 micro-second equalization independently of the tape selector switch. For more detailed explanations, see page 9.

(21) Tape Switch

Allows the choice of recording bias for high-coercivity (SX) and low-noise/high-output (EX) tapes. See page 9 for further information.

(22) Timer Mode Switch

Used in conjunction with the Timer Switch, this selector lets you choose "rec" for unattended recording, or "play" for automatic playback at a pre-set time. An external timer is required for these functions. See page 8.

(23) Timer Switch

When the 580 is plugged into an external timer, depressing this switch will cause the deck to begin recording or playing automatically at a pre-set timer of day. See page 8.

(24) Tape Memory Switch

"Remembers" any starting point on the tape. When you set the tape counter to 000 at the desired point and depress the "memory" switch, the 580 will automatically stop from the rewind mode when the counter reaches 999.

(25) Record Calibration Controls

Screwdriver adjustments to provide record level calibration, essential for proper tracking of the Dolby Noise Reduction circuits. These controls are adjusted using the built-in 400 Hz test tone. See page 10.

(26) Bias Adjustment Controls

Screwdriver adjustments for record bias current. Requires the use of external test instrument. See page 10.

(27) Counter Reset Button

Resets the tape counter to 000 when fully depressed.

(28) Tape Counter

Indicates relative position on the tape. May be used to index selections on the tape.

(29) Left Output Jack

(30) Left Input Jack

(31) Right Input Jack

(32) DIN In/Out Jack

(33) Right Output Jack

(34) Power Cord

(35) Remote Control Socket

The optional RM-580 Wireless Remote Control unit is plugged into this socket. The Remote Control Jack also accepts the RM-10 Remote Control, which is supplied with a 5-meter (15 ft.) cable.

(36) Voltage Selector

AC Voltage is factory set for the country in which the 580 is sold. Voltage selector permits re-setting of mains voltage in case deck is to be used in a different country.

NOTE: Safety regulations in certain countries prohibit inclusion of a voltage selector.

This feature, therefore, may be absent from your deck.

Precautions

- (A) Do not install the 580 close to heat sources (such as radiators), or in a place subject to direct sunlight, excessive dust, or moisture.
- (B) Make sure the timer switch (23) is "off" (out) when you do not desire the self-starting feature. If this switch is depressed, and if the timer mode switch (22) is in the "rec" position, you will begin recording merely by turning on the power switch. A cassette tape already in the compartment and without its protective tabs removed will be erased in such instances. Although this may be an unlikely set of conditions, you can eliminate the possibility of this type of accidental erasure by observing this precaution.
- (C) The 580's head assembly is at the bottom of the cassette compartment. The cassette, therefore, must be inserted with the exposed tape down. (Nakamichi 1000 owners note!) Inserting the cassette upside down, and then forcing the lid shut may cause serious damage to the cassette and the 580.

Connections

There are two ways of connecting the Nakamichi 580 to your preamplifier, amplifier or receiver. You may use shielded cables with RCA plugs (provided with the deck) to connect the left and right input jacks (30, 31) to the "rec" or "tape out" jacks on your preamplifier. In the same way, connect the output jacks (29, 33) to the "tape in", "tape mon", "tape PB" or "aux in" jacks of your preamplifier.

If your preamplifier or receiver is equipped with a DIN socket, you may use a DIN-standard in/out cable to connect the DIN in/out jack of the 580 (32) to the similar jack on your preamplifier. (In this case, do not use RCA cables simultaneously.)

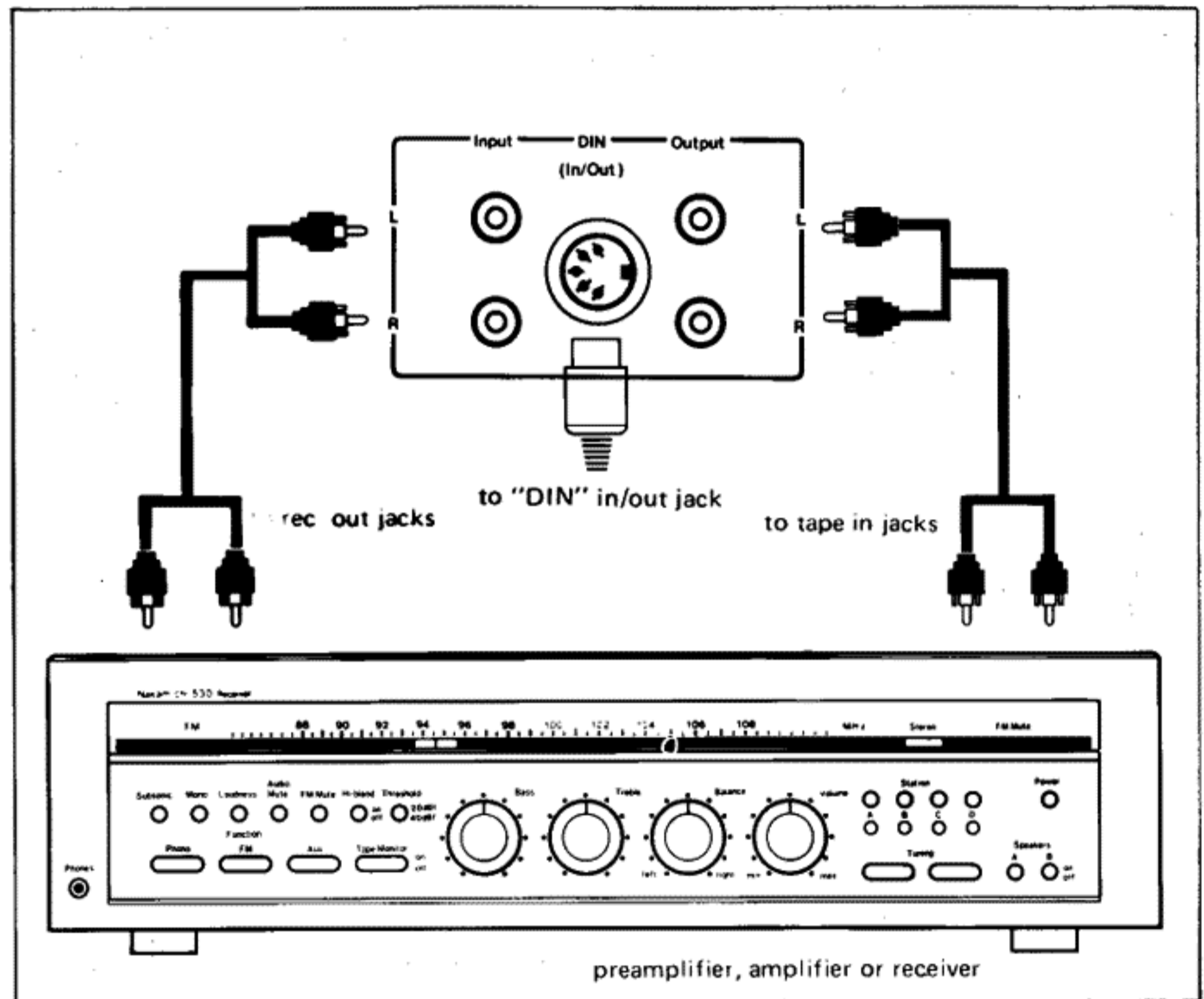

Headphones

Standard stereo headphones may be connected to the headphone jack (4) on the 580's front panel. Low impedance headphones (8 ohms nominal) are recommended.

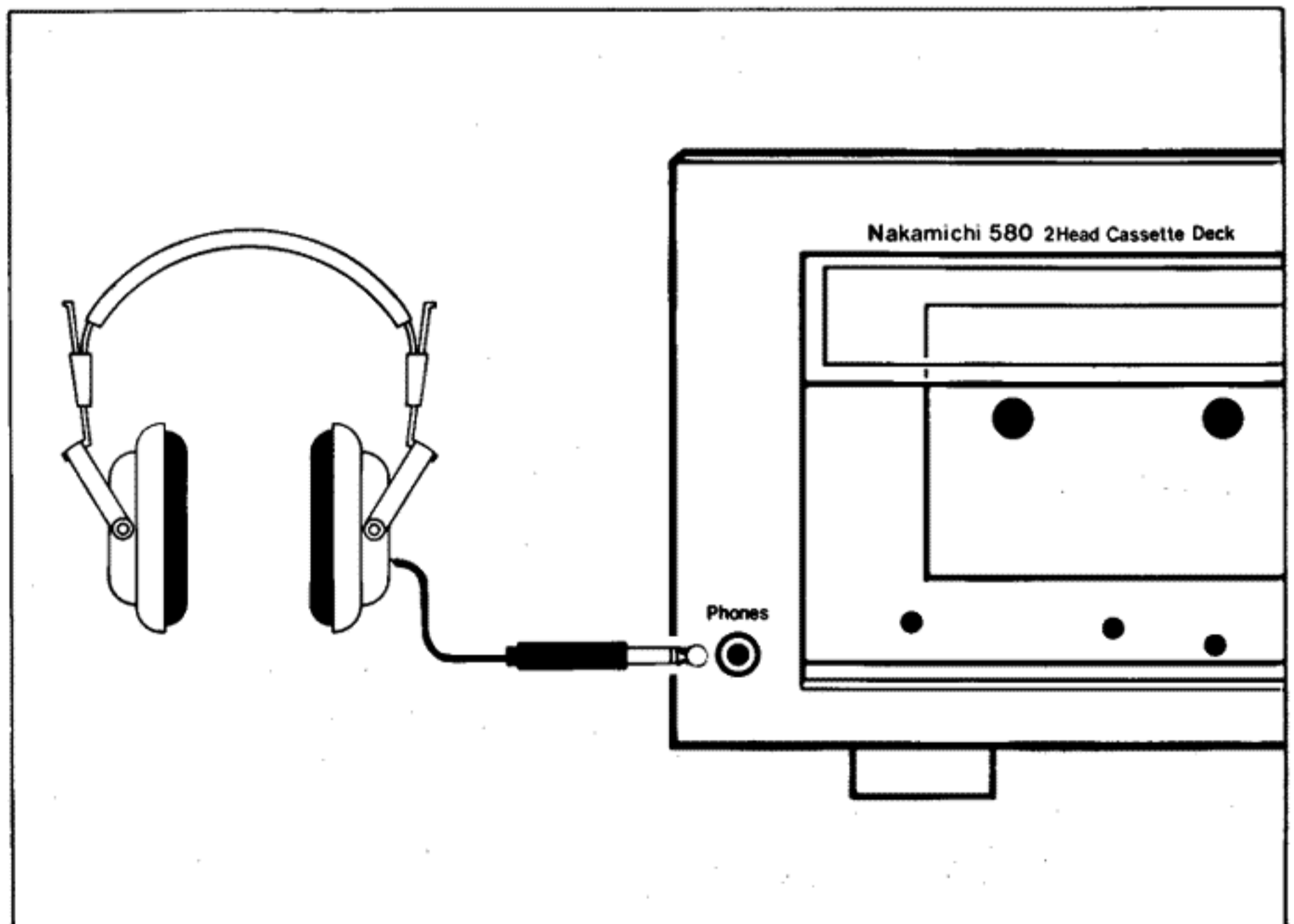

Playback

- (A) Turn the power switch (15) "on" (depress). The cassette compartment and peak level meters will illuminate to indicate power.
- (B) Take a pencil or pen with hexagonal cross-section (or a finger) and gently tighten any loose tape onto the supply reel of the cassette. Loose tape, especially where the tape is exposed, may prevent proper contact with the capstans and pressure rollers.
- (C) Open the cassette compartment lid (3) by pushing the eject button (2).
- (D) Load the cassette into the lid from the top. Make sure the exposed tape is facing down and the label of the desired side is facing you. (See photo.) Close the cassette lid (3) by pushing it gently back into the panel.

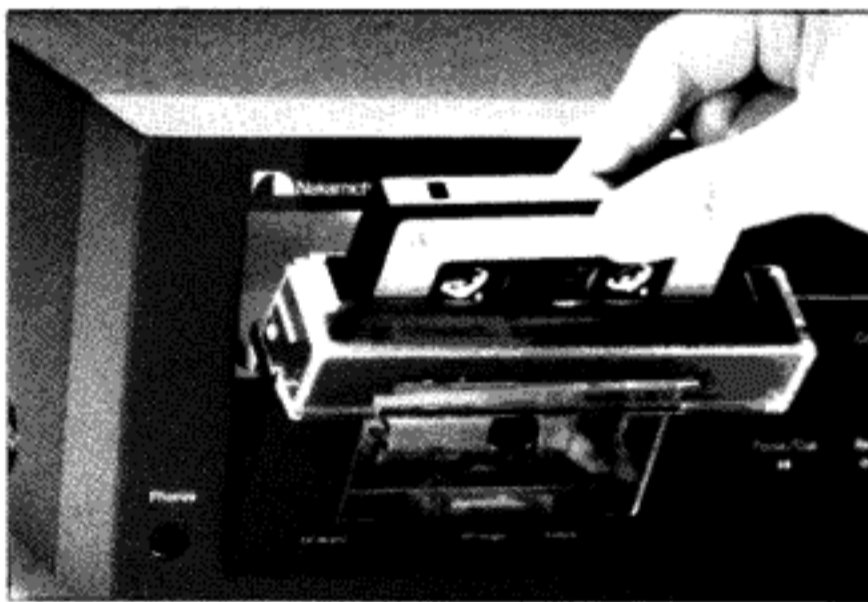

- (E) Set the Eq switch (20) to the required position – either 120 or 70 microseconds. See page 9 for details. The tape selector switch (21) has no effect on playback.
- (F) If the tape was recorded with the Dolby system, set the Dolby NR switch (17) to its "in" (depressed) position.
- (G) Press the play button (11) to start the tape.
- (H) To stop the tape momentarily, press the pause/cue button (6). To resume playback, press the play button (11) again.
- (I) To stop the tape altogether, press the stop button (10). After the tape has stopped, you may eject it by pushing the eject button (2).

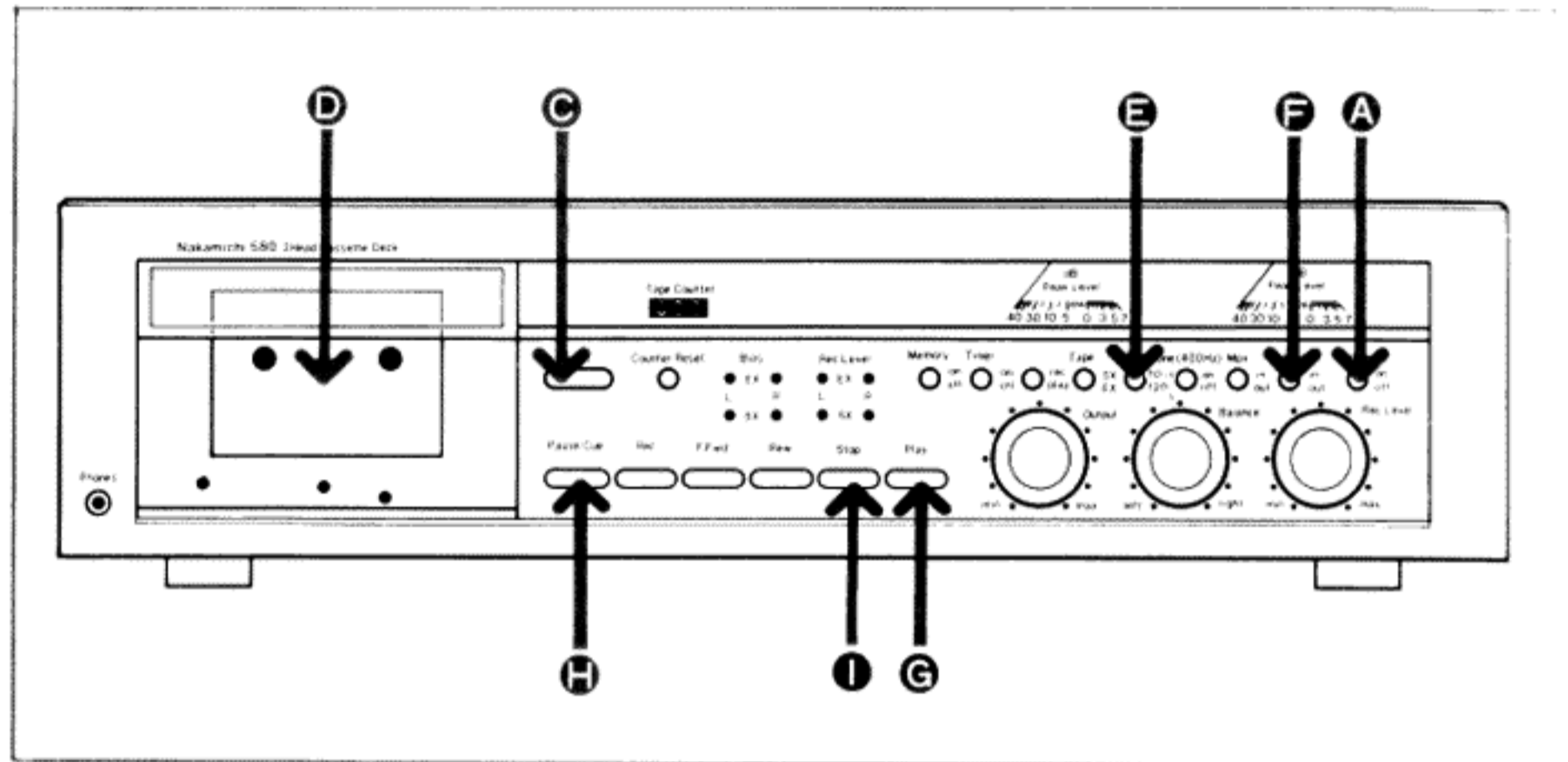

Note:

- You will not be able to eject the cassette in any transport mode other than "stop".
- When the tape reaches its end, or if a defect within the cassette impedes tape motion, the 580's logic circuitry will return the transport to the stop mode automatically.
- Logic circuitry prevents operation of the transport when the cassette lid is open.
- You need not press the stop button when going from one transport mode to another (for example, from rewind to fast-forward).
- During playback, the peak level meters (16) indicate the levels of the signals recorded on the tape. The output level control (12) will affect volume, but it will have no effect on meter readings.
- It is possible to "cue up" a selection on the tape using the 580's unique cueing feature. See the section on "Special Features" (page 8) for instructions.

- (A) Turn the power switch (15) "on" (depress). The cassette compartment and peak level meters will illuminate to indicate power.
- (B) Take a pencil or pen with hexagonal cross-section (or a finger) and gently tighten any loose tape onto the supply reel of the cassette. The tape should be snug for proper contact with the capstans and pressure rollers.
- (C) Open the cassette compartment lid (3) by pushing the eject button (2).
- (D) Load the cassette into the lid from the top. Make sure the exposed tape is facing down and the label of the desired side is facing you. Close the cassette lid (3) by pushing it gently back into the panel.
- (E) Set the Eq and tape selector switches (20, 21) as required. See page 9 for details. If you are using an unfamiliar brand of tape, we recommend that you check the record level calibration before proceeding any further (see page 10 for calibration procedure).
- (F) Set the Dolby NR switch (17) "in" for low-noise recording. Because Dolby decoding will be required for proper playback, be sure to make a note on the cassette label that the tape is Dolby-encoded.
- (G) If your program source is FM stereo, press the mpx filter switch (18) in. Leakage of the 19 kHz multiplex carrier from your tuner may otherwise cause erratic behavior of the Dolby circuits.
- (H) Press the tape counter reset button (27). The tape counter (28) should now read 000. Press the play button (11) and allow the tape to run to a count of 003. Then, press the stop button (10). The first few inches of tape have slight surface irregularities imprinted by the spool and the leader tape is loose. For this reason, it is best not

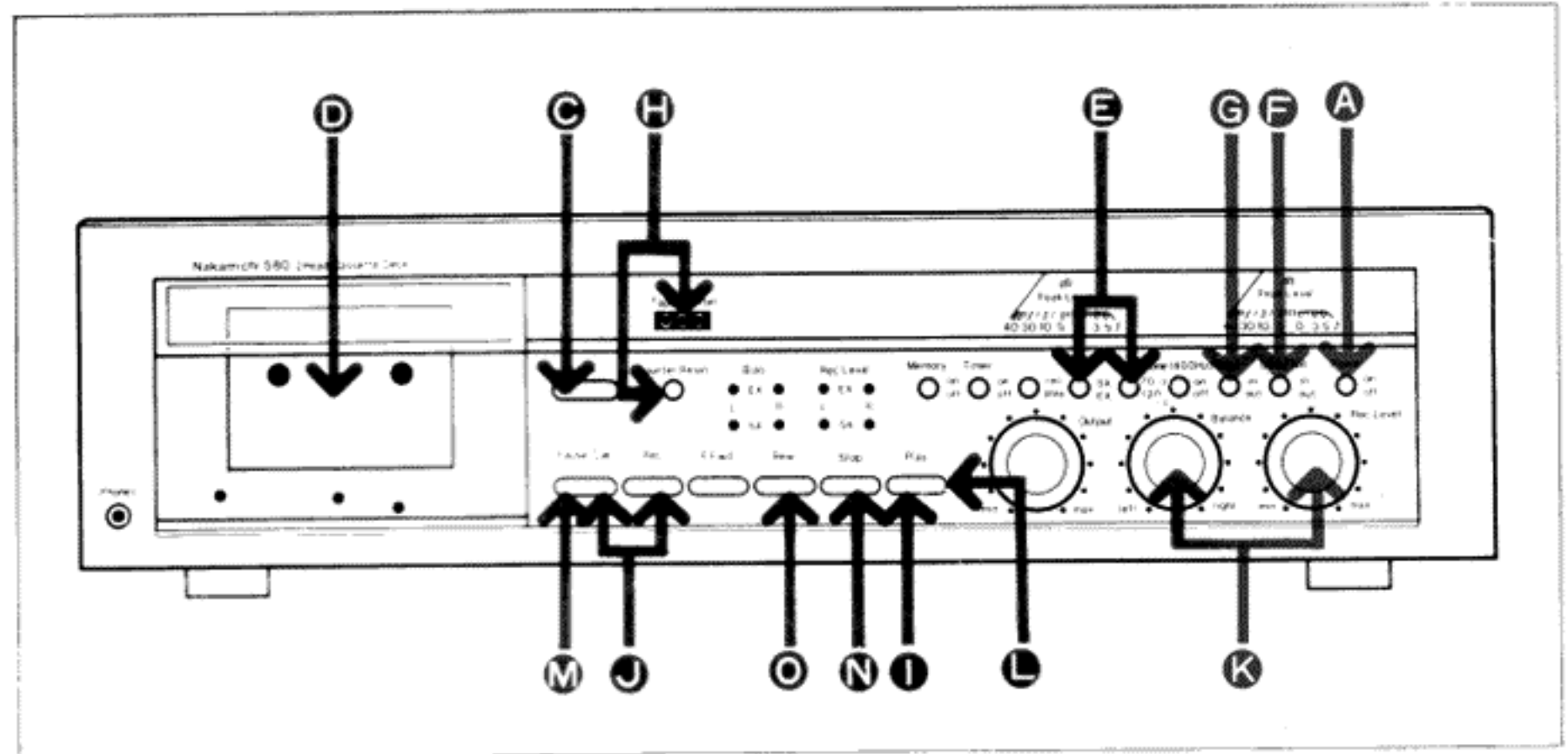

to record from the very beginning of the tape.

- (J) To put the 580 into the record/stand-by mode, press and hold the record button (7) with one finger; while holding this button, press the pause/cue button (6). The red lamp above the record button will light to indicate record mode.
- (K) You are now ready to set the input (record) levels. Use the input level control (14) while playing a portion of your program source to obtain readings on the peak level meter. The balance control (13) is normally left in its center-detent position, but it may be used to correct imbalance of input levels. See the section entitled "Tips on Setting Record Levels" (page 7) for more detailed information on this procedure.
- (L) To commence recording once levels are set, simply press the play button (11).
- (M) To halt recording temporarily, press the pause/cue button (6). Press the play button (11) again when you are ready to resume recording.
- (N) To stop recording altogether, push the stop button (10). When you have completed recording an FM stereo broadcast, remember to return the mpx filter switch (18) to the "out" position.

- (O) If you wish to go back and listen to your completed recording, and if you remembered to reset the tape counter to 000 before you began recording, you can now easily access the start of the recording by pushing the memory switch (24) in, and pressing the rewind button (9). The tape will automatically stop when the counter reaches 999.

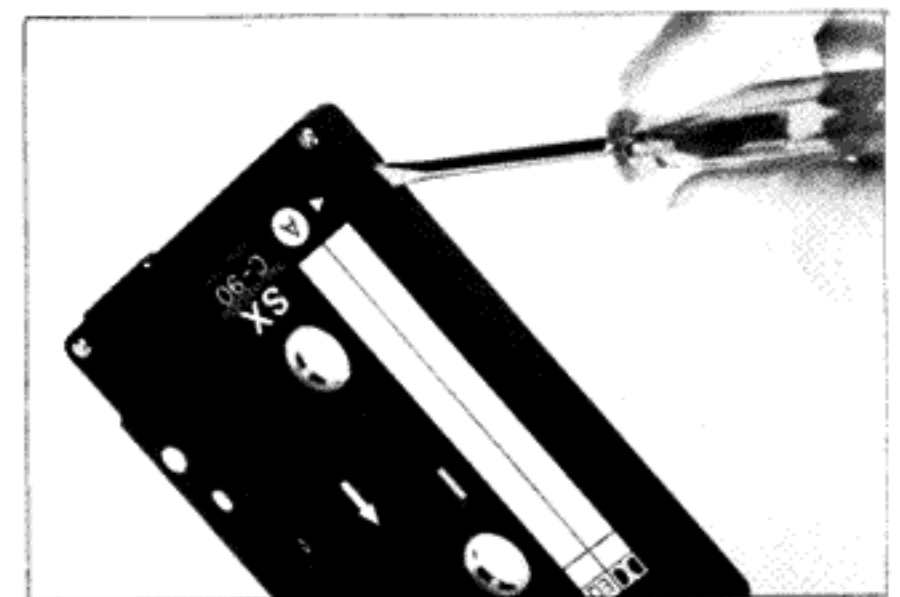

Cassette Tabs

You can protect valuable recordings from accidental erasure and re-recording by completely removing the appropriate tab on the top edge of the cassette. The tab for each side is located on the top-left-hand corner as you face the side. Use a small screwdriver, and push the tab down to break it off. Do not leave the broken tab in the recess. If you wish at a later date to record over a side for which the tab has been removed, cover the tab opening with a piece of adhesive tape.

Live Recording

Although the Nakamichi 580 is not equipped with microphone inputs, its unusually high performance makes it an excellent choice for various live recording applications. An external microphone mixer is, of course, required for this purpose. We highly recommend the Nakamichi BlackBox MX-100 Microphone Mixer, which features three mic inputs. The third input is for a "blend" or center-channel microphone, enabling you to record with the Nakamichi three-point live recording system. The MX-100 operates with the BlackBox PS-100 Power Supply.

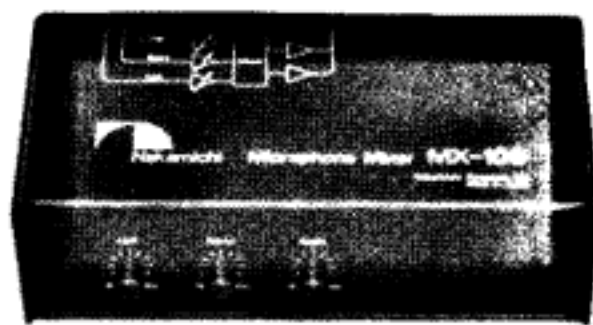

MX-100 Microphone Mixer

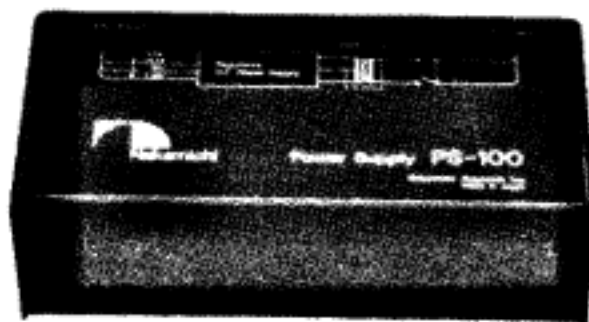

PS-100 Power Supply

Tips on Setting Record Levels

The proper setting of record levels requires practice and patience. Setting the level too high will result in tape saturation, which is audible as a grossly distorted recording. Low recording levels result in unacceptably noisy recordings because there is not enough of the signal on the tape to overcome the "hiss". Record level indicators vary in their effectiveness, but even the best indicator system is not totally foolproof. It takes experience to know just how much signal one can put on the tape. The best setting will be determined by the type of tape in use, the type of source material to be recorded and, to some degree, personal preferences of the user (some are willing to sacrifice signal-to-noise ratio for the totally distortion-free recording while others are willing to tolerate occasional tape saturation for quieter recordings).

The fast-acting peak-level meters of the Nakamichi 580 are more accurate than the so-called VU meters found on most cassette decks. Conventional meters are not fast enough to give accurate indications of musical peaks. The illustration below shows that there can be as much as 18dB difference between a peak-reading meter and a conventional meter on a transient signal, even though the two meters give the same reading on a continuous signal.

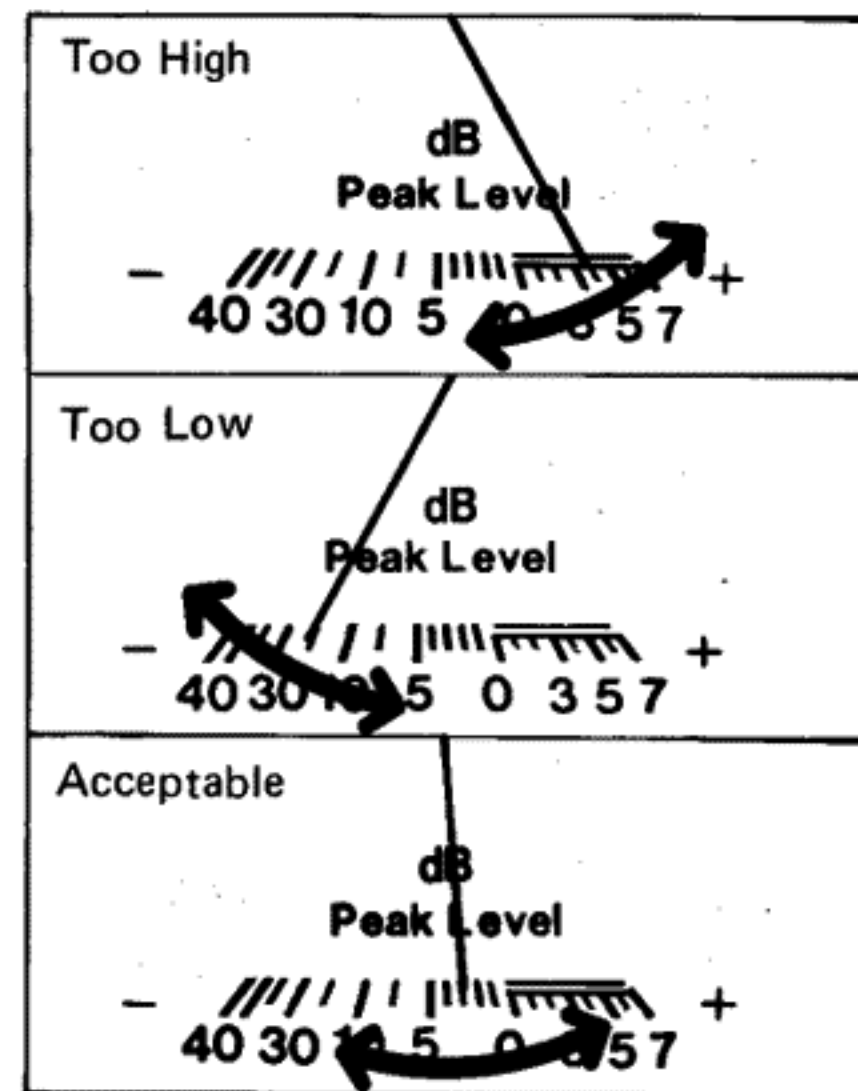

As a guide, begin by setting the record levels so that the meters occasionally "peak" into the red region above 0 dB on a loud portion of the signal source. Brief excursions as high as +5 to +6 dB generally do not result in noticeable saturation. If the needles stay above 0 dB for long periods, however, you are almost certainly producing an unacceptably distorted recording. You can, of course, check whether the levels have been correctly set by making a brief sample recording of the loudest passages and listening carefully while playing it back. This is only possible, however, if your source is pre-recorded material, such as an LP record or another tape.

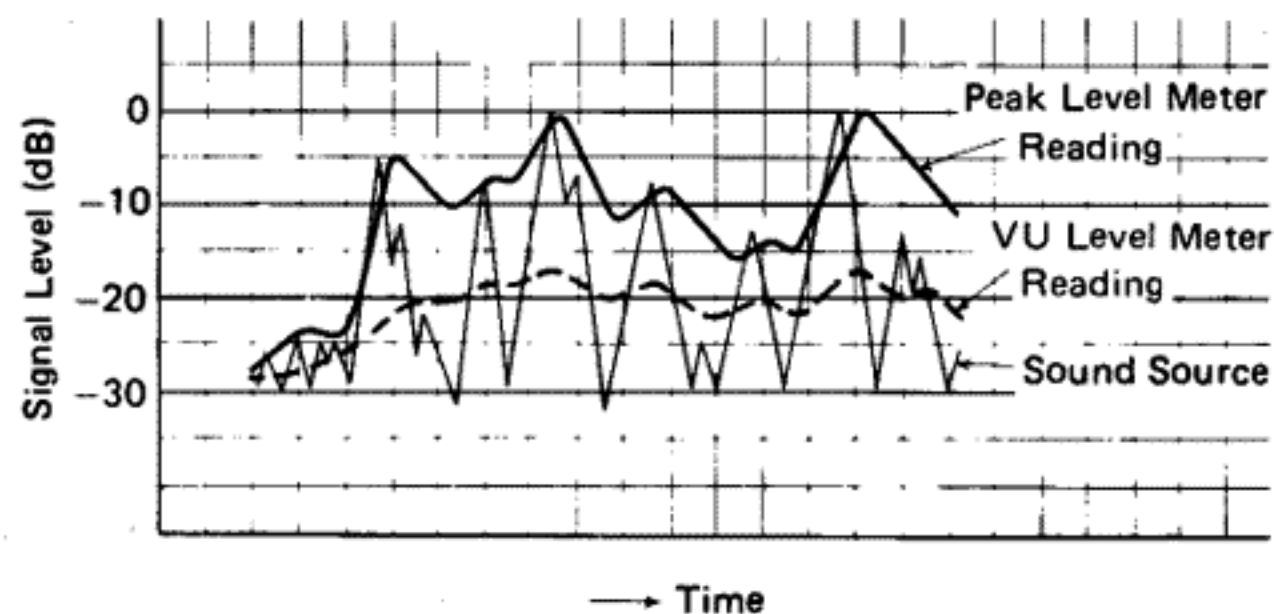

Special Features

Tape Start Memory

The memory switch (24) and the tape counter (28) work in conjunction to provide a handy method of re-locating any starting point on the tape. Whether you are recording or playing back, press the counter reset button (27) at any point on the tape if you think you will want to return to that point. By pressing the counter reset button, you will ensure that the tape counter will begin from 000. Later in the tape, when you want to return to your starting point, simply push the memory switch (24) in and press the rewind button (9). The transport will stop automatically stop at a counter reading of 999.

Timer Operation

The 580 has a built-in self-start feature which enables you to make unattended recordings. This feature can also be used to have the 580 begin playing a cassette at a pre-selected time of day. To take advantage of this feature, you must use a timer, such as the Nakamichi DS-200 Digital Program Timer. An ordinary appliance timer can also be used, although this type of timer generally does not allow you to precisely set starting time.

Plug the AC power cord of the 580 into an AC outlet on the timer. Any other component which is to be turned on at the same time as the 580, such as a tuner or receiver, must also be plugged into the timer. If the timer provides only one outlet, use it for the tuner or receiver, and plug the 580's power cord into one of the outlets on the rear of the tuner or receiver. With the system's power "on", load a cassette into the 580, and make all necessary level adjustments (input levels for unattended recording, volume levels for automatic playback). Then, set the timer for the desired starting time. Make sure all the necessary power switches are "on".

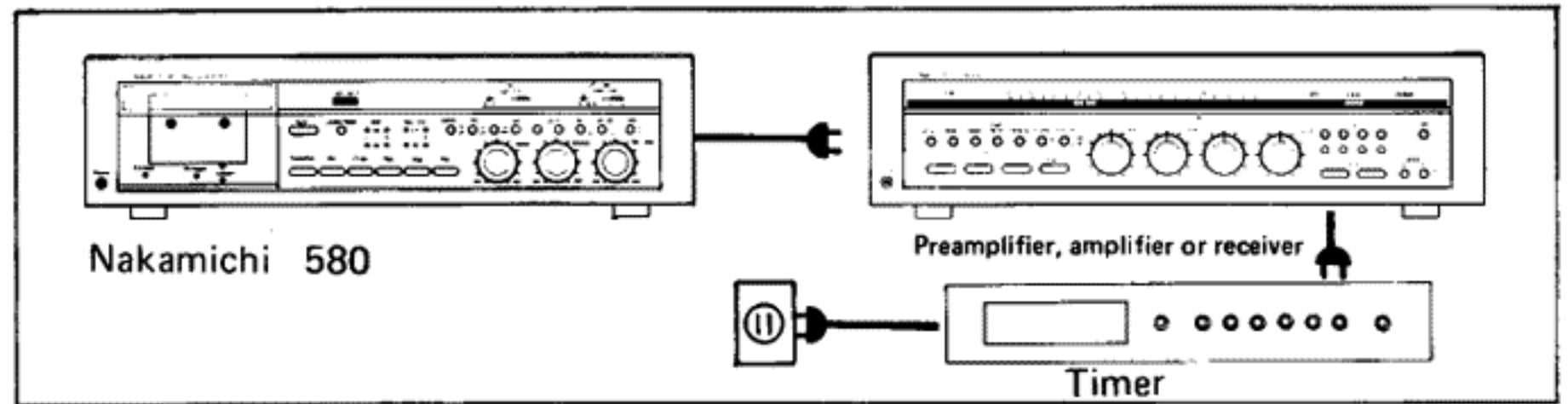

Push the timer switch (23) to its "on" position (depressed). If you want to make an unattended recording, also push the timer mode switch (22) in. Leave the mode switch out if you want automatic playback — otherwise, you may inadvertently erase the cassette when the timer turns the system on. (This can be avoided by punching out the erasure-protection tabs on the cassette.)

At the desired time of day, the timer will turn on your system, and the 580 will begin recording or playing (depending on the setting of the mode switch).

Cueing

When the tape is shuttling during rewind or fast-forward, the head assembly is normally retracted and the output muted so that you do not hear the unwanted, high-pitched sounds that would otherwise result. But these high-pitched signals, if somewhat reduced in speed, can be used to locate the blank spots which mark the end of one selection and the beginning of the next. Most professional, open-reel tape decks offer just such a feature. It is called cueing.

The 580 provides a unique feature quite similar to cueing systems found on professional equipment. While you are in rewind or fast-forward, you can hear the tape in high-speed motion by pressing the pause/cue button (6). Pressing this button while the deck is fast-winding will move the playback head closer to the tape and reduce winding speed to one-third. You can further reduce winding speed (to

approximately one-fifth by pressing the rewind or fast-forward button (9, 8) after you have first pressed the pause/cue button. You will remain in cueing mode until you press the stop button (10) or the play button (11).

Remote Control

It is possible to operate the Nakamichi 580 from a remote location by using one of two optionally available remote controls.

The RM-580 is a wireless system consisting of a transmitter and a receiver section. The receiver section can be placed near the tape deck and is plugged in via a short cable to the 580's remote control socket (35). The deck can then be controlled by a hand-held transmitter, which sends infra-red, pulse-code signals to the receiver section.

The RM-10 is a remote control system which enables operation of the 580 from a distance of 5 meters (approx. 15 ft.). The cable from the remote control unit plugs directly into the 580's remote control socket (35).

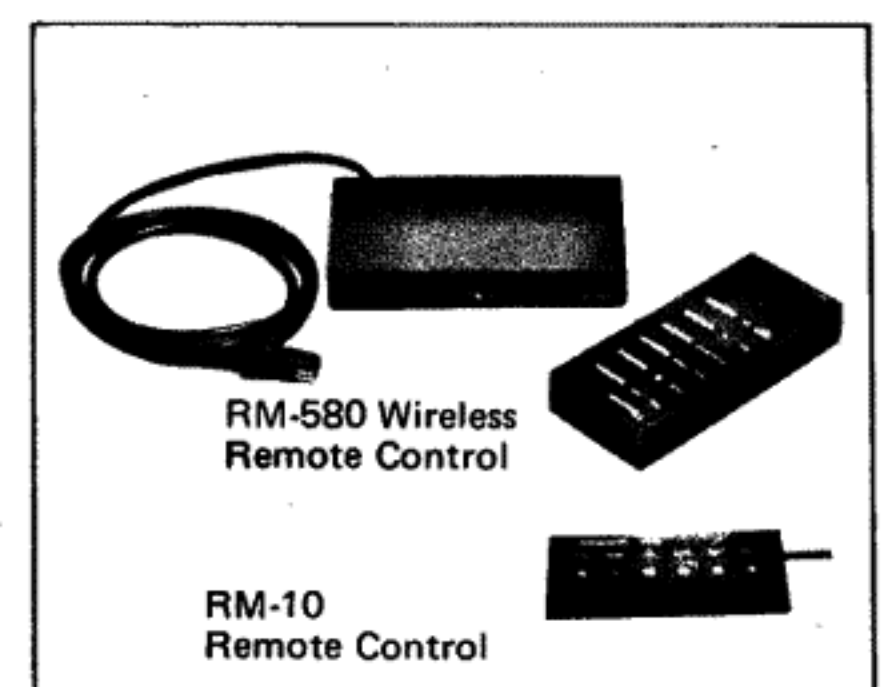

Recommended Tape



type of tape. Unlike bias, the Eq switch must be set for both record and playback. Low-noise/high-output tapes, including Nakamichi EX and EXII, require the 120-microsecond equalization time constant. High-coercivity tapes, such as Nakamichi SX, use the newer 70-microsecond time constant. Normally you would set the EQ switch according to the chart.

The excellent high frequency performance of Nakamichi heads permits unusual settings of the Eq switch for special purposes.

Recommended Tape

Extended high frequency response and low distortion can only be obtained through proper matching of cassette tape and cassette deck bias and equalization settings. The chart shows the cassette tapes currently recommended for use with Nakamichi decks and the proper tape (bias) switch (21) settings for approximate compatibility. Also shown are the Eq switch (20) settings for each tape. Tapes other than Nakamichi are listed in alphabetical order. In all cases, Nakamichi recommends the C-60 and C-90 lengths.

Tape Switch (Bias)

Bias is an inaudible high frequency tone used to reduce the distortions and nonlinearities inherent in the magnetic tape recording process. For many years there was only one type of tape. Only engineers needed to concern themselves with bias. Today different formulations of tape require different biasing. The tape switch (21) sets the bias level applied to the tape during recording. (The switch does not affect playback.)

Nakamichi EXII tape and other low-noise/high-output tapes require one level of bias, sometimes termed "normal." High-coercivity tapes, such as Nakamichi SX, require 45% more bias. Your Nakamichi 580 has been factory adjusted for Nakamichi EXII and Nakamichi SX tapes. The other recommended tapes are roughly compatible in their respective categories. On page 11 of this manual, you will find a detailed procedure for fine-tuning the bias for optimum recording with each tape formulation.

(A) If you record a high-coercivity tape for someone who does not have 70-microsecond equalization (sometimes labeled the "CrO₂" or "Chrome" position) on his cassette machine, record with the tape switch in the SX position and the Eq switch in the 120-microsecond position.

(B) The term "headroom" refers to the margin of safety above which the tape will be saturated and severely distorted. With more headroom, you can record stronger signals without saturation. For extended high-frequency headroom at some sacrifice of signal-to-noise ratio with high-coercivity tape, record with the tape switch in the SX position and the Eq switch in the 120-microsecond position. Be sure to make note of the special equalization on the cassette label and to play back with the 120-microsecond setting.

(C) For better signal-to-noise performance at some sacrifice of high-frequency headroom with low-noise/high-output tape, record with the tape switch in the EX position and the Eq switch in the 70-microsecond position. As above, make note of the special equalization and play back with the 70-microsecond setting.

RECOMMENDED HIGH-COERCIVITY TAPES

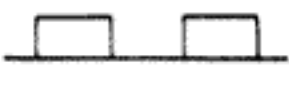
Tape/Eq Settings	Brand	Formulations
SX 70 	Nakamichi Ampex Fuji Maxell TDK	SX Grand Master I FXII UDXL-II SA

RECOMMENDED LOW-NOISE/HIGH-OUTPUT TAPES

Tape/Eq Settings	Brand	Formulations
EX 120 	Nakamichi Ampex Fuji Maxell TDK	EX, EXII Grand Master I FXI UD, UDXL-I AD

Eq Switch

Equalization is used in record and playback to achieve optimum signal-to-noise performance for different tape formulations. Like bias, the proper Eq switch (20) settings must be selected for each

Record Calibration and Bias Adjustment

The various tapes in the two broad categories described on page 9 are approximately compatible. It is best, nevertheless, to choose one brand of tape for each of the two positions and use these two consistently. By doing so, you need not worry about the compatibility of a new and different kind of tape, and you will gain familiarity and confidence in recording which cannot be gained if you are constantly changing brands. But even the best of tape manufacturers will often change the characteristics of one of their products without notice. (You may also simply want to try a new or different brand.) It is recommended, therefore, that you periodically check record calibration and, if possible, bias.

Record level calibration can be easily performed on the 580 without the use of any external test instruments. Proper level calibration is essential for accurate tracking of the Dolby noise reduction circuits. The procedure described below is simple enough to follow; and once you gain familiarity with this calibration, it will take only a few minutes to perform.

Bias adjustment is a more complicated affair. You must have an external signal generator or oscillator in order to perform this adjustment. The instructions outlined in this section will enable you to adjust bias if you have the necessary equipment. But if, after reading the procedure, you are unsure in any way, it is best to call on a qualified service technician for assistance. In general, bias adjustment is required only if your recordings sound "dull" or "bright" in comparison to the original program source.

Record Calibration

- (A) Load a cassette as before.
- (B) Set the Eq and tape selector switches (20, 21) according to the type of tape in use. See page 9 for further details.
- (C) Set the test tone switch (19) "on" (depressed). This will activate the built-in 400 Hz oscillator, which now overrides any external input to the 580.
- (D) Begin recording the 400 Hz test tone by pressing the record and play buttons (7, 11) simultaneously. The peak level meters will read 0 dB. This recording level is not affected by the input level or balance controls (14, 13).

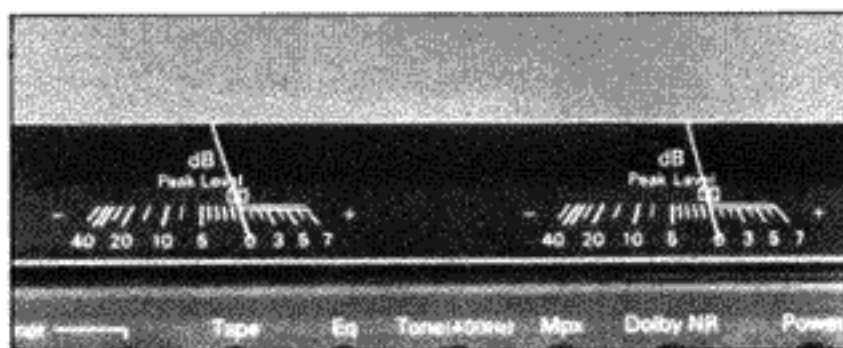

- (E) Record the tone for 15–20 seconds. Then, rewind and play back the tone.
- (F) Observe the meters during playback, and make mental notes. Then, stop the transport.
- (G) If both meters registered within one dB of the "0 dB" mark during step (F), there is no need to perform further calibration. If not, you should make corrections using the

small screwdriver supplied with the 580 and turning the appropriate "rec cal" controls (25). There are separate controls for each tape position (EX and SX) and for each channel (L and R). Turn clockwise to correct a low reading. Turn counter-clockwise to correct a high reading.

- (H) Repeat steps (D) through (G) until the meters read within one dB of "0 dB" during playback.

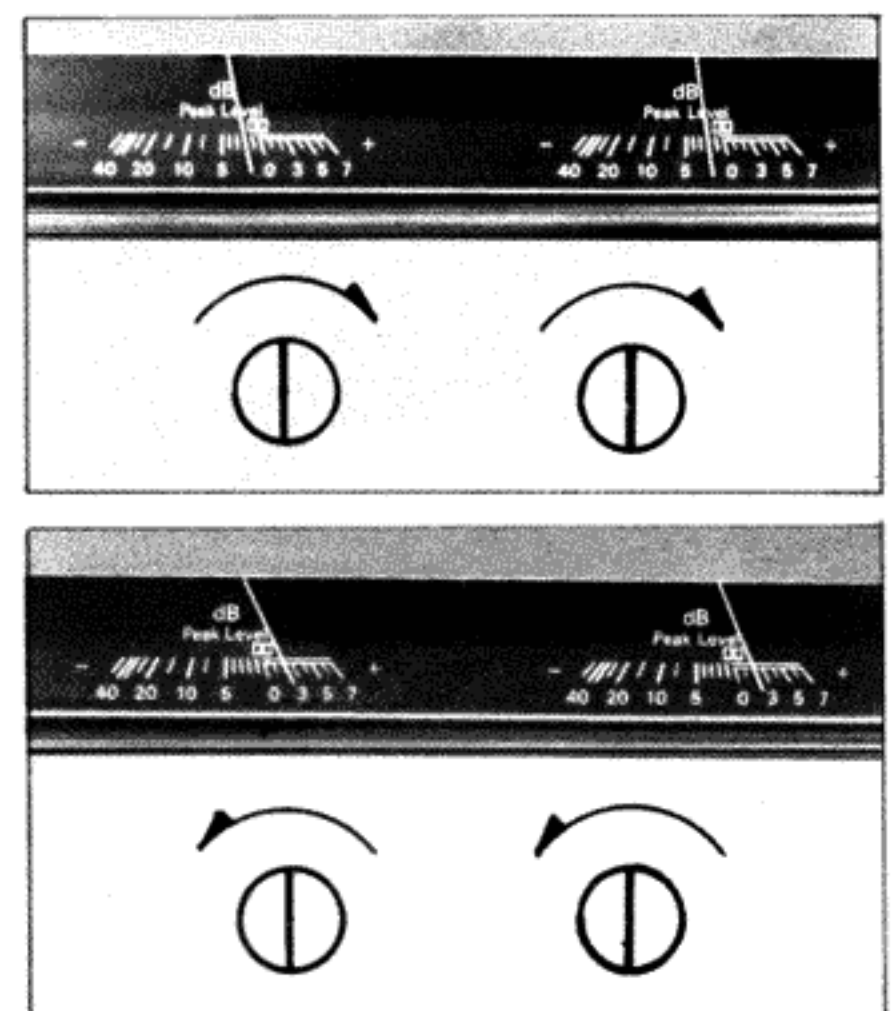

Note: Do not expect the meter indications to change while you are adjusting the "rec cal" controls. You must follow the procedure outlined above in order to obtain the desired results.

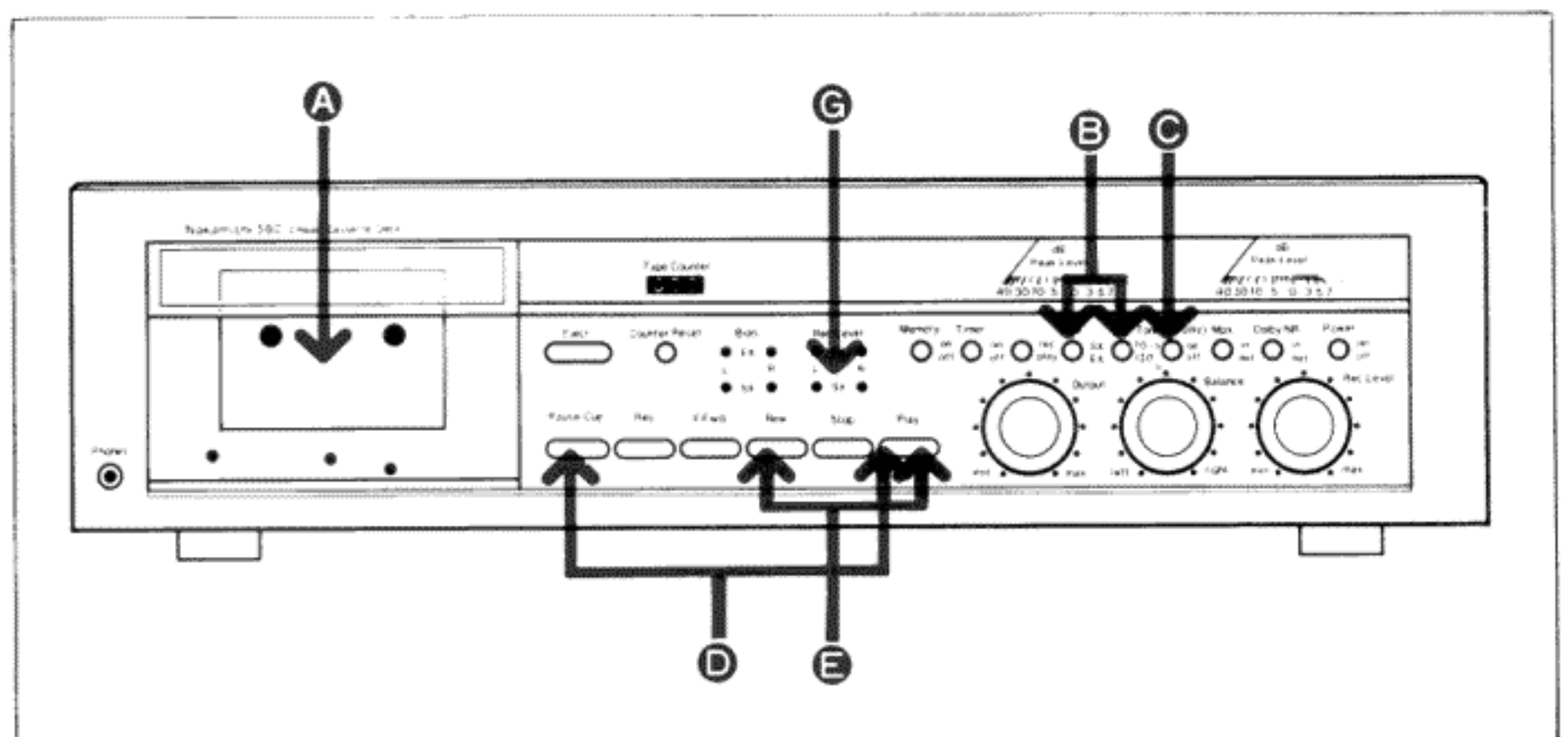

Bias Adjustment

The Nakamichi T-100 Audio Analyzer is highly recommended for this adjustment. If you are using the T-100, follow the detailed instructions supplied with the Analyzer.

It is possible to adjust bias reasonably accurately with the use of an external audio oscillator. The test tones built into the Nakamichi 610 Control Preamplifier, for example, can be used for this purpose. In this case, follow the procedure outlined below:

- (A) Load a cassette as before.
- (B) Set the Eq and tape selector switches (20, 21) according to the type of tape in use. See page 9 for detailed information.
- (C) Set the Dolby NR switch (17) to its "out" position.
- (D) Connect the output of the oscillator to the input jacks (30, 31) of the 580.
- (E) Put the 580 into the record/stand-by mode by holding the record button and pressing the pause/cue button (7, 6).
- (F) Adjust the oscillator output and/or the 580's input level and balance controls (14, 13) to obtain a reading of -20 dB on the peak level meters using a 1 kHz signal.
- (G) Start the tape, and record several seconds each of 1 kHz, 10 kHz and 15 kHz, all at -20 -dB record level. Make sure the output from your oscillator is equal at all three frequencies. (If you are using the Nakamichi T-100 or 610, you need not be concerned about this point).
- (H) Rewind the tape, and play back the three signals. They should all play back at -20 dB (plus or minus 2 dB). The tape counter (28) and a pair of headphones can be useful in identifying the three tones. If the response is approximately equal for all three frequencies, you need not continue

with this procedure.

- (I) If the playback level varies widely among the three test tones, check for other causes, such as dirty heads or erroneous Eq/bias settings, before proceeding with the bias adjustment.
- (J) To adjust bias, use the small screwdriver and turn the appropriate bias adjustment controls (26). There are separate controls for each tape type (EX and SX) and each channel (L and R). Turn clockwise to reduce high frequency response. Turn counter-clockwise to increase high frequency response. Always make adjustments in small steps — a slight turn of the bias adjustment control can have a pronounced effect on frequency response.
- (K) After making adjustments, re-check response by repeating steps (G) and (H).

Note:

- Do not expect playback levels to change while you are turning the bias adjustment controls. You must follow the procedure outlined above to ensure proper bias adjustment.
- Although it is possible to adjust the 580 to perform acceptably with just about any kind of tape by following the above procedure, the best overall performance (especially in terms of frequency response, distortion and noise) can only be assured if you are using a high quality cassette tape. Consult the list of recommended tapes on page 9.)
- It is a good idea to re-check record level calibration after performing bias adjustments.

The Dolby System

What it will and will not do

The Dolby Noise Reduction circuits of the 580 reduce the hiss inherent in the tape recording process. The Dolby system cannot reduce the noise of your source material. If your records, FM broadcasts, microphones, and other sources are noisy, the cassette deck's Dolby system will not improve them. But the Dolby system will reduce tape noise by as much as 10 dB.

The Dolby system has an encode (record) and a decode (playback) process. Dolby-encoded cassettes should be labeled as such; when played back without the proper Dolby decoding, they will sound unnaturally "bright". Conventional (non-Dolby encoded) cassettes will sound unnaturally "dull" when played back with Dolby decoding. This boosting and cutting of the high frequencies has much to do with how Dolby Noise Reduction is accomplished.

How the system works

The Dolby encoder boosts the high-frequency program content before it goes onto the tape. The Dolby decoder gives the high frequencies equal and opposite treatment during playback. While the decoder returns the high-frequency content to original levels, it simultaneously reduces the high-frequency noise incurred in the recording process.

Because noise is more noticeable during quiet passages than during loud passages, the Dolby system does not treat all high frequency signals equally. It gives more of a boost to low-level high-frequency signals than it does to high-level high-frequency signals. This variation of the Dolby system's effect across the dynamic range distinguishes Dolby Noise Reduction from simply "turning up the treble" on record and "turning down the treble" on playback.

"Turning the treble" up and down is, in

fact, the basic idea behind tape record and playback equalization, RIAA phono equalization, and FM pre-emphasis/de-emphasis. All of these systems involve boosting the high frequencies at one end and equal reduction of high frequencies at the other. All work to reduce noise. But the amount of boosting in each case is limited by the headroom characteristics of the medium. In the case of tape recording, too much equalization (too strong a high-frequency boost) will saturate the tape and distort the recording. Hence there is a limit to the amount of noise reduction attainable through equalization alone. FM pre-emphasis and phono equalization face similar limitations.

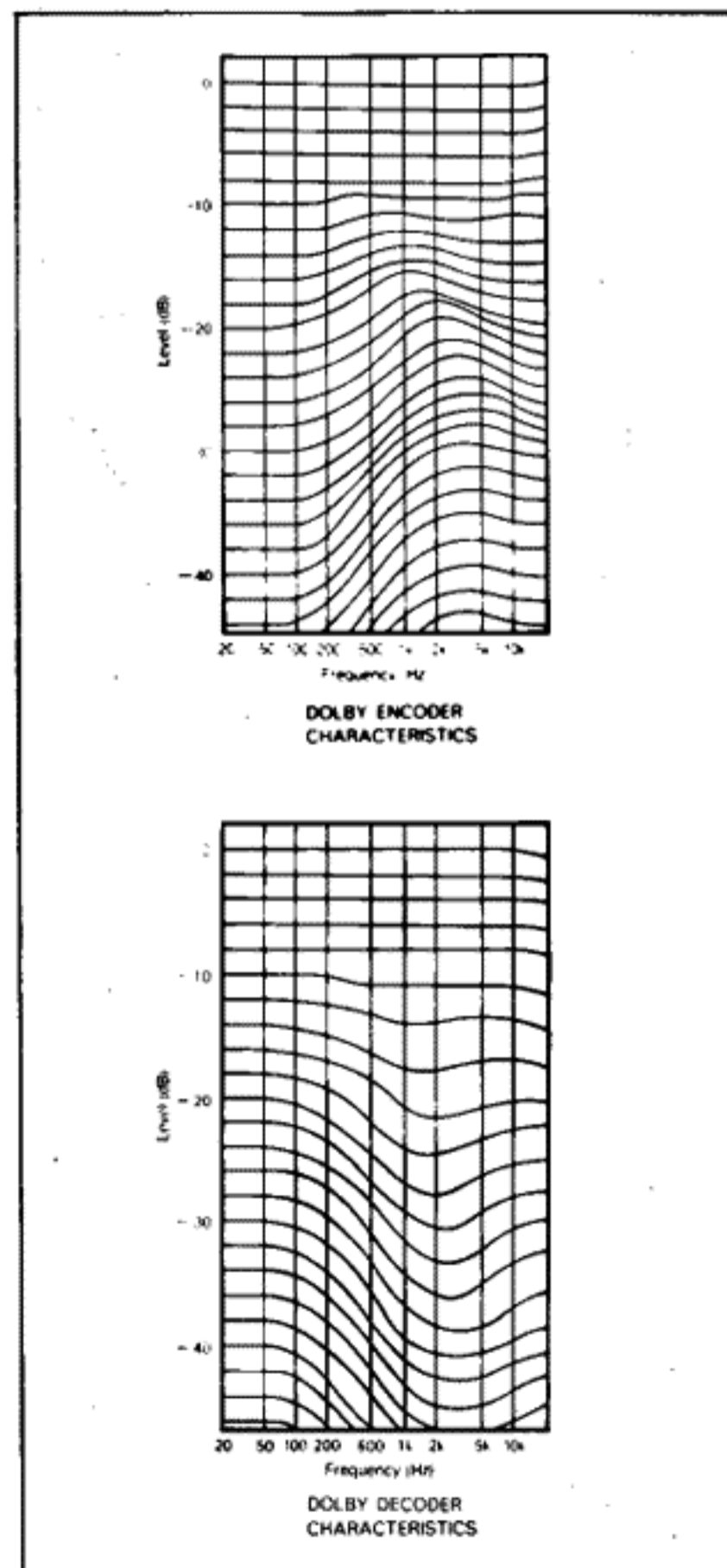

The Dolby Noise Reduction system does not, because the Dolby system only boosts low-level signals. This provides an additional 10 dB of noise reduction without threatening the headroom of the medium.

Why is level calibration necessary?

The "rec cal" controls of the Nakamichi 580 are used in conjunction with the 400 Hz reference test tone. The adjustment assures that a tone recorded at 0 dB will play back at 0 dB. Although tape formulations of the same category (Page 9) pose the same equalization requirements, variations in tape sensitivity will cause one formulation to provide more output than another formulation. The controls permit you to adjust the deck for the sensitivity of each formulation you use.

Without calibration, the Dolby circuits could potentially mis-track on different formulations. Recording on a more sensitive formulation without recalibrating would mean that a test tone recorded at 0 dB would play back at higher than 0 dB. The Dolby recoder would fail to provide the full high frequency cut, and the tape would sound slightly "bright" on playback. Conversely recording on a less sensitive tape without recalibrating would produce slightly "dull" playback. Level calibration is essential for Dolby system compatibility from cassette to cassette.

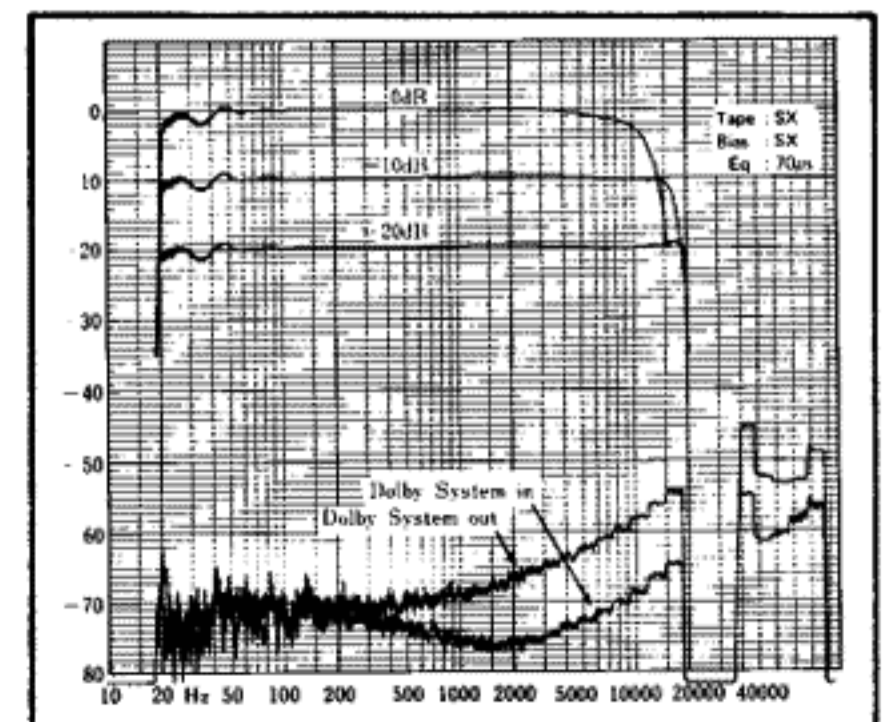

Maintenance

Head and Transport Cleaning

To maintain the Nakamichi 580's superior performance and to prolong the life of the heads and pressure rollers, all parts that come into contact with the tape should be cleaned frequently and thoroughly. Dirty heads, capstans or pressure rollers may result in any of the following symptoms:

- Uneven sound levels.
- Loss of high frequencies.
- Wow and flutter.
- Damage to cassette tapes.
- Tape squeal caused by excess friction.

Even the best cassettes deposit oxide sheddings onto the heads, capstans and pressure rollers. Clean a minimum of once every ten hours of use, even if you use premium tapes. If you must use inferior brands of tape, you may need to clean after each playing. By observing the amount of contamination accumulated on the cleaning stick pad or cotton tip, you will be able to judge whether you are cleaning the 580 frequently enough. Repeated cleanings, if properly done, will not harm the deck. Hence, it is impossible to clean too often.

A Cleaning Kit consisting of a plastic stick, sponge tips, cotton tipped sticks and a container of alcohol is supplied with your Nakamichi 580. When the alcohol runs out, use commercially available isopropyl alcohol (preferably undiluted). "Q-tips" and other cotton swabs may be used in the place of the sponge tips. Do not, however, rely on head cleaning cassettes. Some head-cleaning cassettes are unduly abrasive and may damage the heads. None of them clean the capstans and pressure rollers properly. Perform all cleaning with alcohol. Use the plastic stick with a sponge tip screwed onto its end. A cotton-tipped stick is equally effective, but be careful not to leave strands of cotton on any of the cleaned parts.

Clean in the following sequence:

- (A) Turn the power switch (15) on. Push the eject button (2) to open the cassette lid. Carefully pull the acrylic cassette compartment cover (1) out of the cassette lid. Push the cassette lid back into its well.

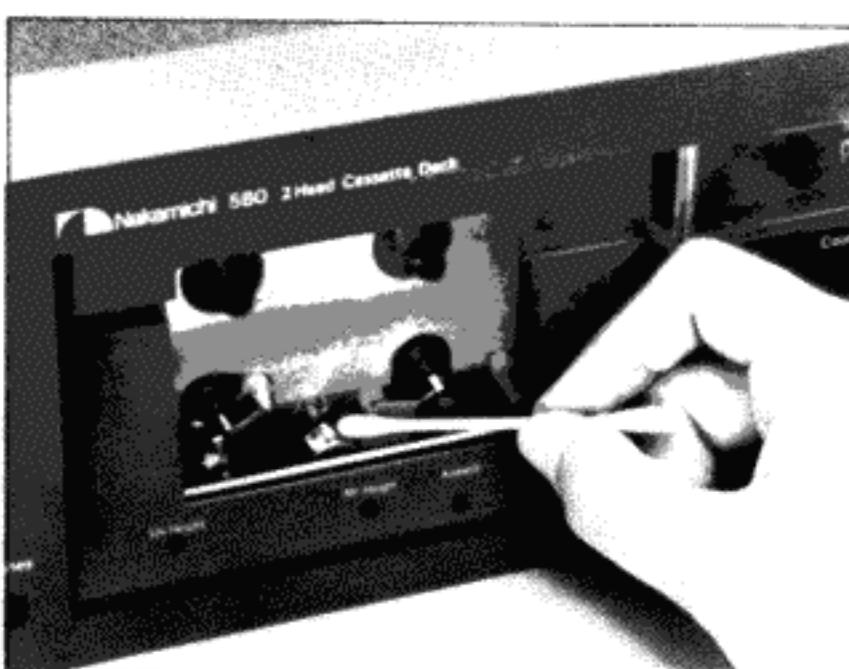
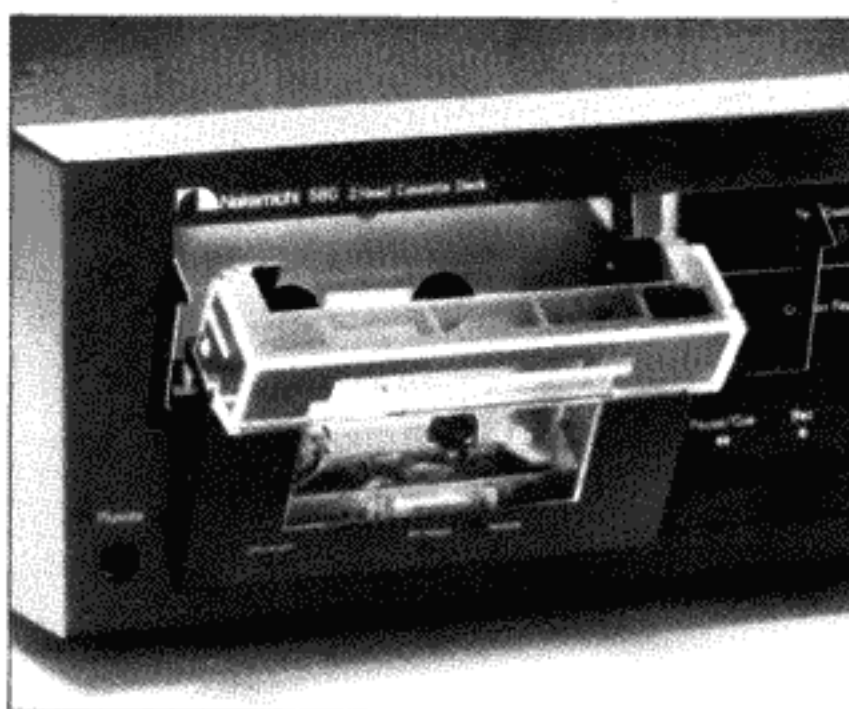

- (B) With a cleaning stick dipped in alcohol, clean the surfaces of the record/playback and the erase heads. Clean with short, firm, back-and-forth strokes along the path of tape travel. Also be sure to clean the tape guides on both heads.
- (C) Press the play button (11). Carefully apply the cleaning stick to one pressure roller as it turns. Use light pressure and an up-and-down stroke to cover the entire width of the roller. Repeat with the other pressure roller. If you are using a cotton-tipped stick, make sure to apply the tip to the side of the roller rotating away from the capstan; the cotton may otherwise get caught between

the capstan and the roller (if this should happen, simply press the stop button and remove the cotton).

- (D) With the transport in the stop mode, apply a clean section of the cleaning stick pad to one capstan. Move the pad up and down the capstan shaft as it turns. Repeat with the other capstan.
- (E) Press the eject button, and carefully re-insert the acrylic cover.

Cleaning is now completed, but give the cleaned surfaces a minute or two to dry off completely before playing a tape.

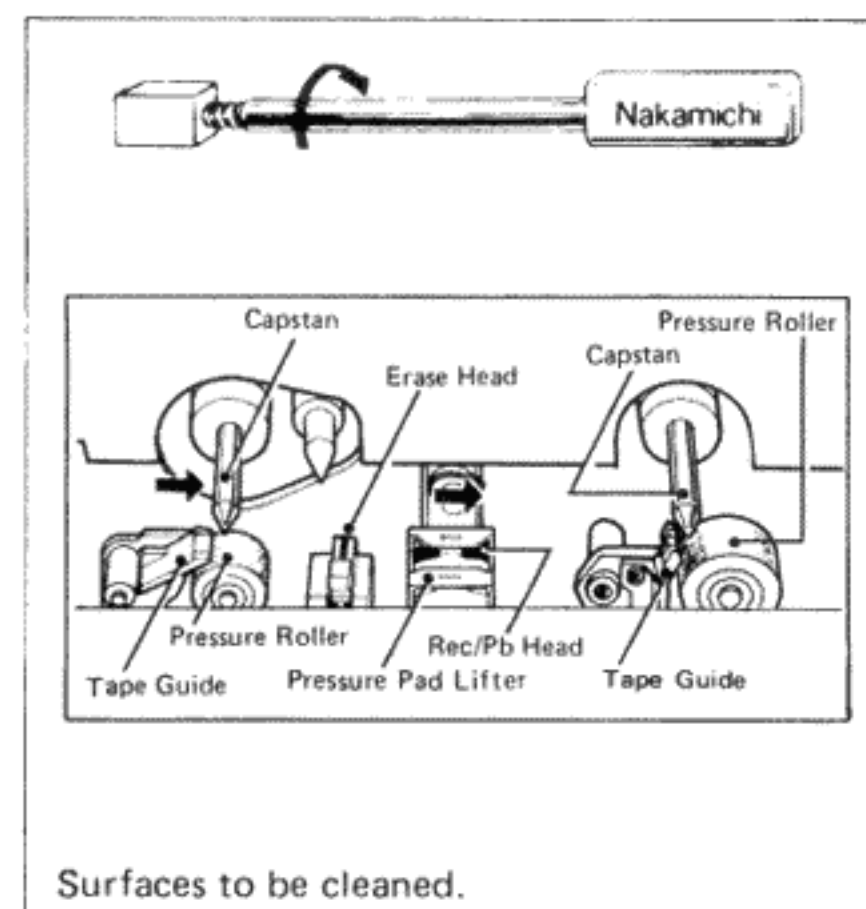

CAUTION: The tape guide and heads are critically aligned at the factory. Do not exert too much pressure on these parts. It is better to stroke repeatedly than to stroke forcefully.

- Do not flood various parts with cleaning alcohol. After dipping the stick into alcohol, squeeze off any excess.
- Be sure to remove any cotton strands from the cleaned parts.

Demagnetizing

All metal parts that come into contact with the tape must be occasionally demagnetized to prevent the build-up of residual magnetism. Such magnetism can add hiss to a tape being played and partially erase the high frequencies. Although the heads and capstans of Nakamichi cassette decks require demagnetizing less frequently than those of most other cassette decks, you should nevertheless demagnetize once every 50 hours of use to be on the safe side.

The Nakamichi DM-10 Demagnetizer is recommended since it has been specifically designed for cassette decks, but any properly designed demagnetizer will do.

- (A) Remove all tape from the vicinity of the tape deck before proceeding. Make sure the 580's power switch (15) is off. Remove the cassette compartment cover (1). Push the cassette lid back into its well.
- (B) Turn the demagnetizer on while it is at least two feet away from the deck. Slowly bring the tip as close as possible to the record/playback head. Do not make contact with the head unless the tip of the demagnetizer is covered with vinyl or rubber to prevent scratching the record/playback head's surface. A piece of vinyl tape may be used to cover the tip if it is not already covered.
- (C) Move the demagnetizer slowly in a random pattern about the surface of the head for at least 10-seconds. Then, move the demagnetizer to one capstan then the other, repeating the random pattern for 10 seconds. (It is not necessary to demagnetize the erase head.)
- (D) After demagnetizing the capstans, slowly withdraw the demagnetizer from the deck. Wait until the demagnetizer is at least two feet from the deck before turning the demagnetizer off. Never turn it off while it is close

to a head or a capstans as this may semi-permanently magnetize the part.

Lubrication

The moving parts of the Nakamichi 580 transport are fitted with oil-less bearings. Periodic lubrication is not necessary.

Cleaning the Faceplate

Remove dust or smudges with diluted detergent applied with a soft cloth. Never use solvents, ammonia, or abrasive cleaning agents.

Head Height and Azimuth

The head height and azimuth adjustments of the Nakamichi 580 are calibrated at the factory for optimum performance. Readjustment should only be done by qualified service technicians.

Repairs

Your Nakamichi 580 has been designed for long service life. Should your 580 require servicing, please consult your Nakamichi dealer or the Nakamichi dealer nearest you. As there are no user-serviceable parts inside the unit, please do not attempt your own repairs.

Troubleshooting

	Probable Cause	Remedy
Tape does not run.	<ol style="list-style-type: none"> 1. Power cord is unplugged. 2. Tape is loose inside cassette. 3. Cassette is not properly seated. 	Plug in cord firmly. Wind tape up. Eject and re-insert cassette.
Cannot record.	<ol style="list-style-type: none"> 1. Input disconnected. 2. Head dirty. 3. Cassette tabs have been removed. 	Check connections. Clean head. Place adhesive tape over tab opening or use new cassette.
Cannot play back.	<ol style="list-style-type: none"> 1. Output disconnected. 2. Dirty head. 	Check connections. Clean head.
Excessive playback hiss.	<ol style="list-style-type: none"> 1. Head is magnetized. 2. Recording volume is too low. 	Demagnetize head. Adjust recording levels.
Distorted playback.	<ol style="list-style-type: none"> 1. Program material is itself distorted. 2. Recording levels are too high. 	Check program material. Adjust recording levels.
Unsteady tape travel.	<ol style="list-style-type: none"> 1. Capstan and/or pressure roller dirty. 2. Tape packing inside cassette faulty. 	Clean these parts. Replace cassette.
Incomplete erasure.	Erase head is dirty.	Clean head.
Weak high frequencies.	<ol style="list-style-type: none"> 1. Dirty heads. 2. Magnetized head. 3. Improper bias level for tape. 	Clean heads. Demagnetize head. See section on Bias Adjustment.
Hum heard during record or playback.	<ol style="list-style-type: none"> 1. Induction fields near deck. 2. Signal cable grounding faulty. 	Keep deck away from amplifier, transformers, fluorescent lamps, etc. Replace signal cables.

Specifications

Specifications:

Power Source	100, 120, 120/220-240, 220 or 240V; 50/60Hz
Power Consumption	20W Max.
Tape Speed	1-7/8 ips. (4.8 cm/sec.) ±1%
Wow and Flutter	Less than 0.1% WTD Peak, 0.05% WTD rms
Frequency Response	20-20,000 Hz ±3 dB (SX, EXII Tapes, -20 dB Rec. Level)
Signal to Noise Ratio	Better than 60 dB at 400 Hz, 0 dB, IHF-A WTD rms.
(Dolby NR In, SX Tape,)	Better than 63 dB at 400 Hz, 3% THD, IHF-A WTD rms.
Total Harmonic Distortion	Less than 1.5% at 400 Hz, 0 dB (SX, EXII Tapes)
Erase	Better than 60 dB below saturation level at 1 kHz
Separation	Better than 37 dB at 1 kHz, 0 dB
Crosstalk	Better than 60 dB at 1 kHz, 0 dB
Bias Frequency	105 kHz
Input	50 mV, 50 k ohms
Output Level	1V (400 Hz, 0 dB, Output Level at Max) 3.3 k ohms
Headphone	45 mW
Dimensions	500(W) x 130(H) x 350(D) m/m 19-11/16(W) x 5-1/8(H) x 13-25/32(D) inches
Approximate Weight	8.3 kg, 18 lb 5 oz

- Specifications and appearance design are subject to change for further improvement without notice.
- Dolby NR under license from Dolby Laboratories.
- The word "DOLBY" and the Double-D-Symbol are trademarks of Dolby Laboratories.

Optional Accessories



SX Cassette Tape C-60, C-90



EXII Cassette Tape C-60, C-90



EX Cassette Tape C-60, C-90



Head Demagnetizer



RM-520 Wireless Remote Control

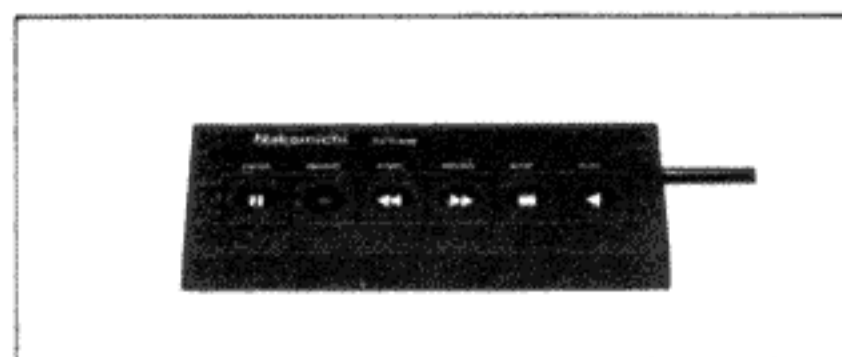

RM-10 Remote Control

Nakamichi Corp.

1-153 Suzukicho, Kodaira, Tokyo
Phone: (0423) 42-1111
Telex: 2832610 (NAKAM J)
Cable: NAKAMICHI KOKUBUNJI

Nakamichi U.S.A. Corp.

220 Westbury Avenue
Carle Place, N.Y. 11514
Phone: (516) 333-5440
Telex: 144513 (NAKREI CAPL)

Nakamichi U.S.A. Corp.

1101 Colorado Avenue
Santa Monica, Calif. 90401
Phone: (213) 451-5901
Telex: 652429 (NAKREI SNM)